

Fig. 4-24. - Couverts.

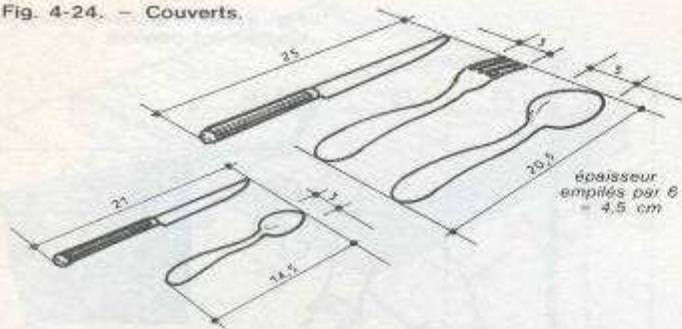

Fig. 4-25. - Linge.

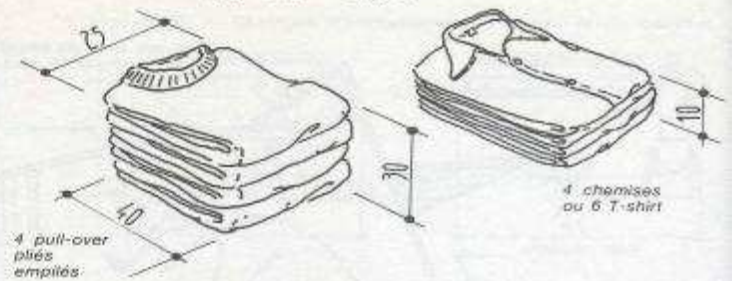
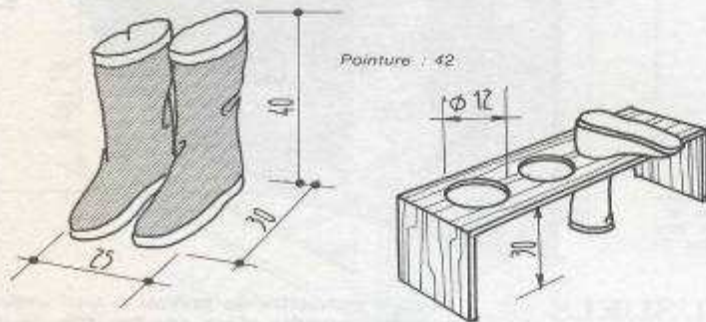
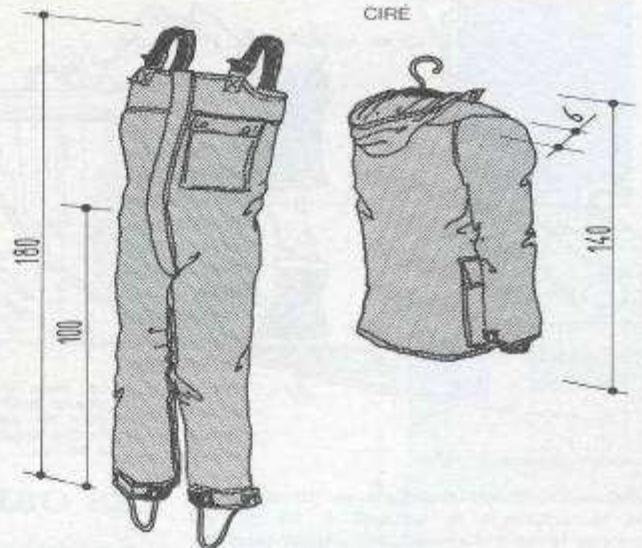

Fig. 4-26. - Bottes.



CIRÉ



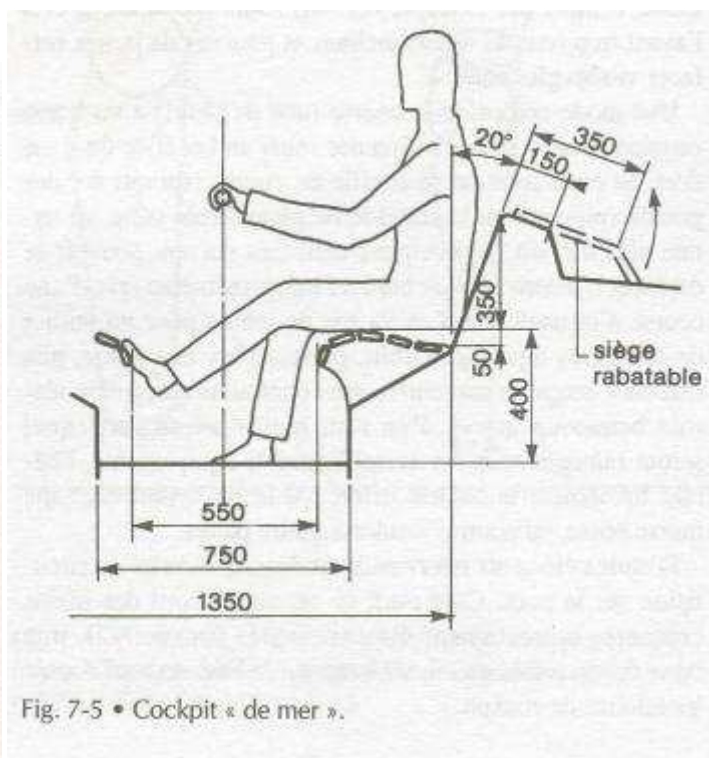
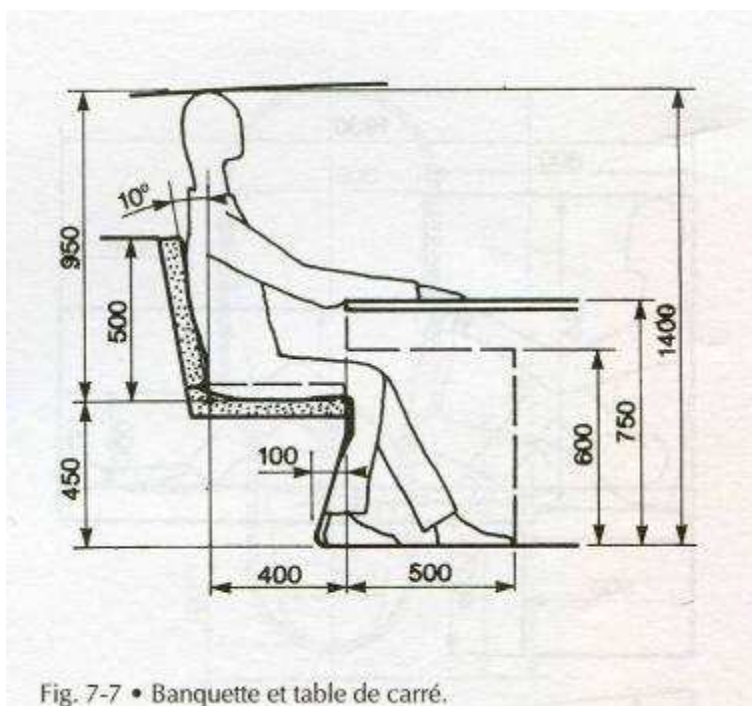
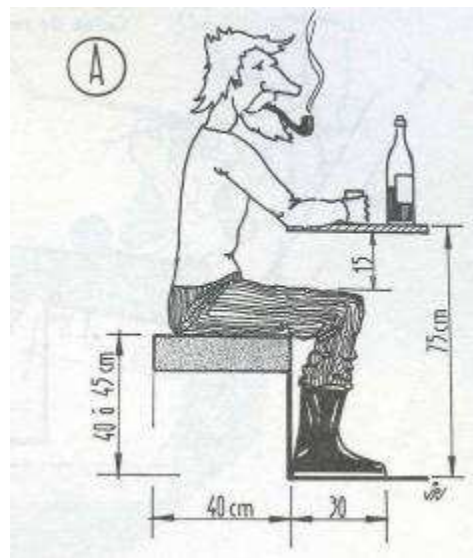
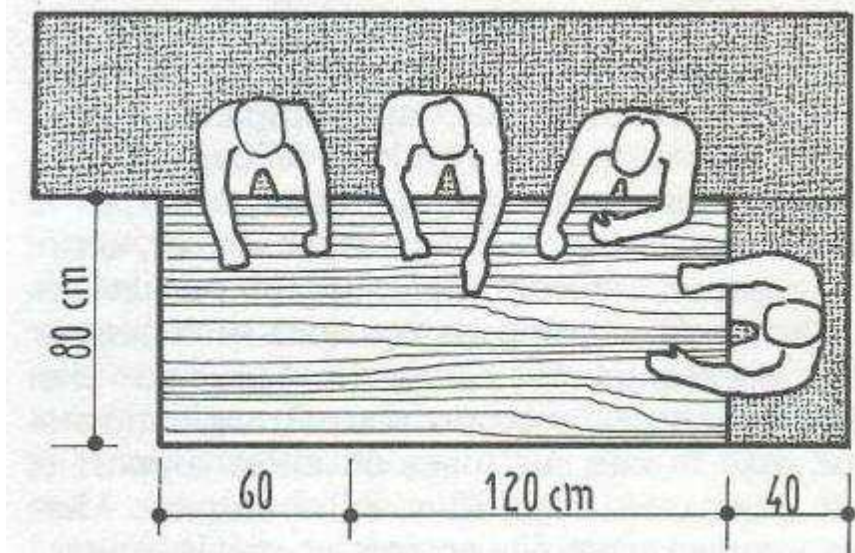

Fig. 7-7 • Banquette et table de carré.

Fig. 7-5 • Cockpit « de mer ».

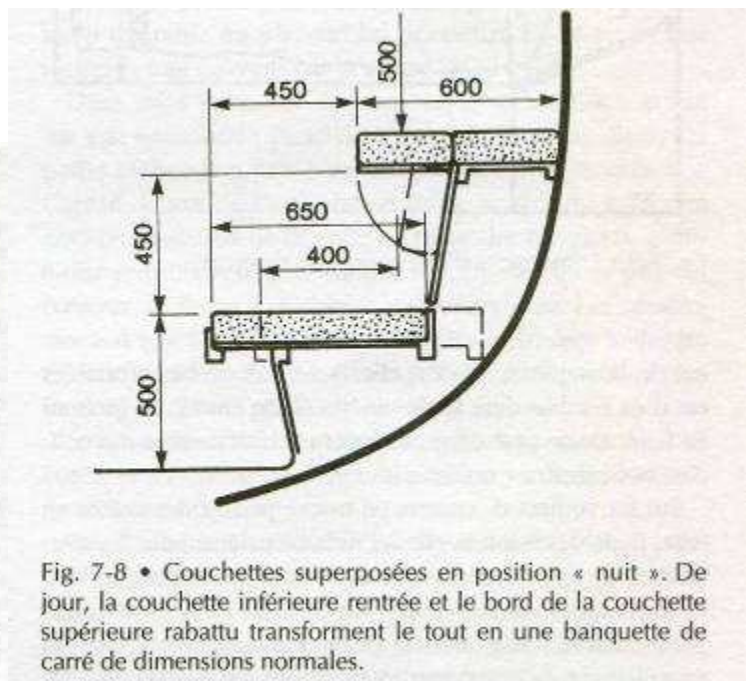
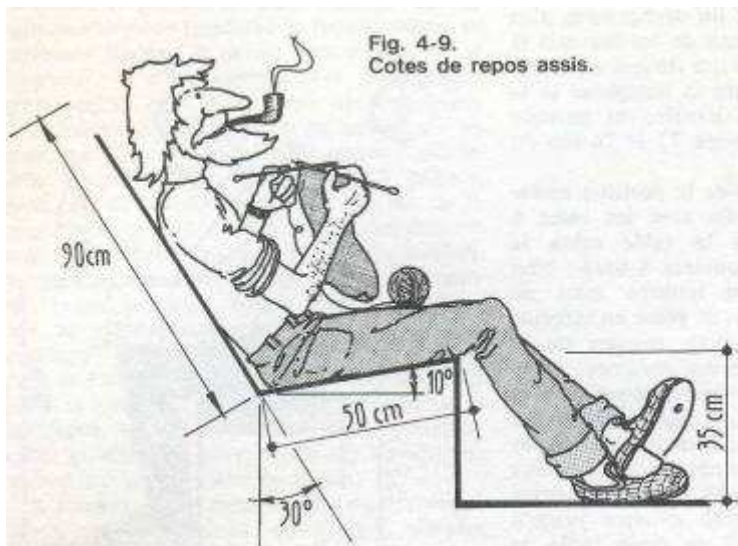
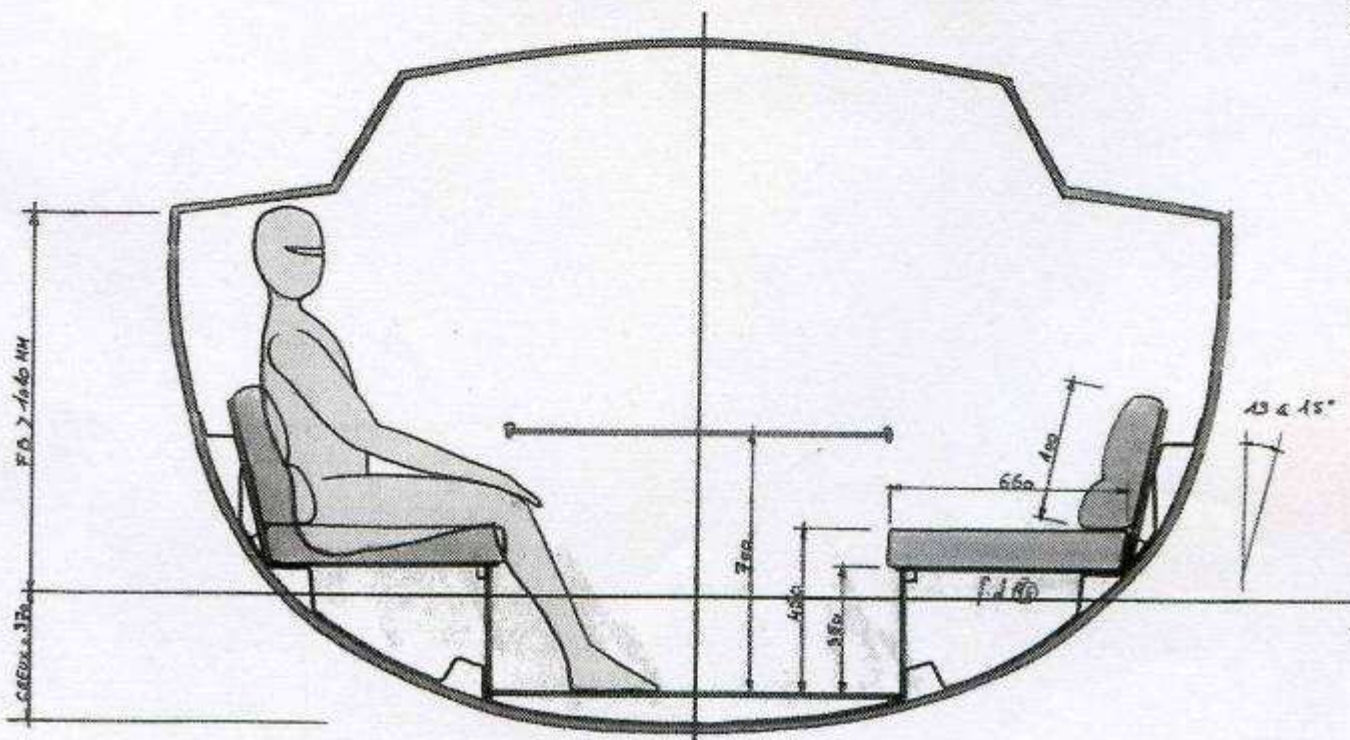
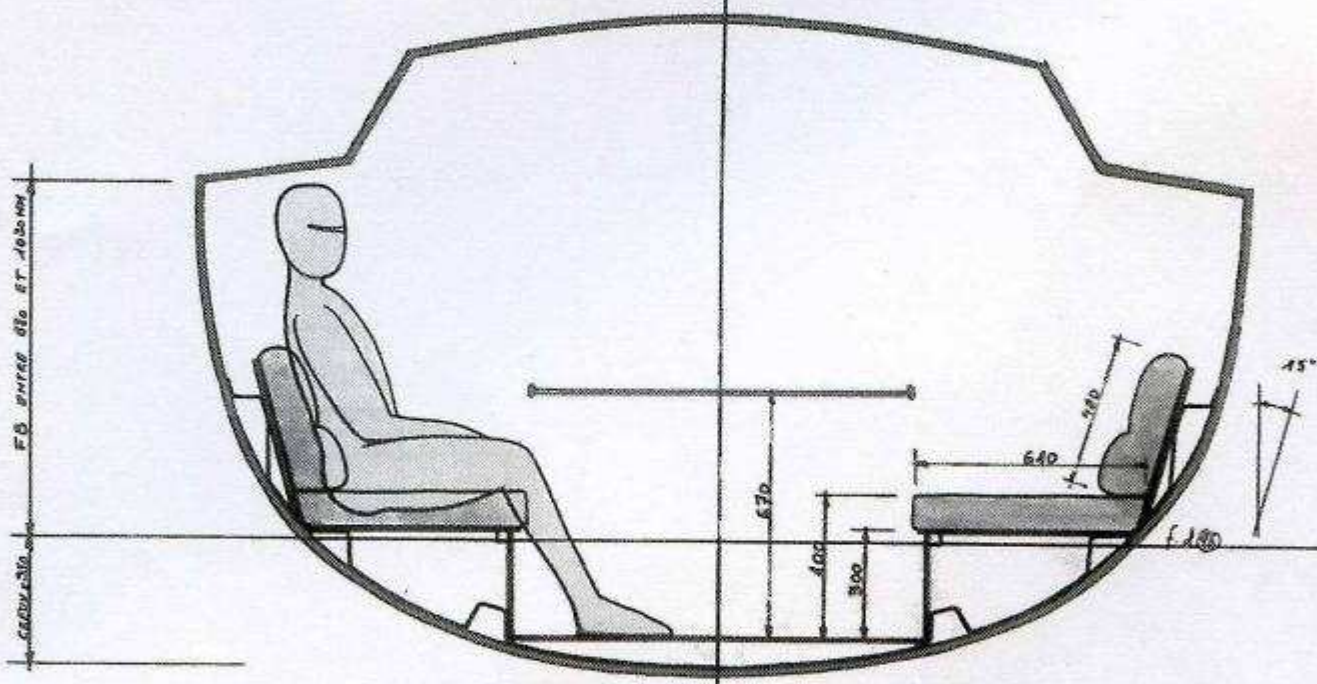
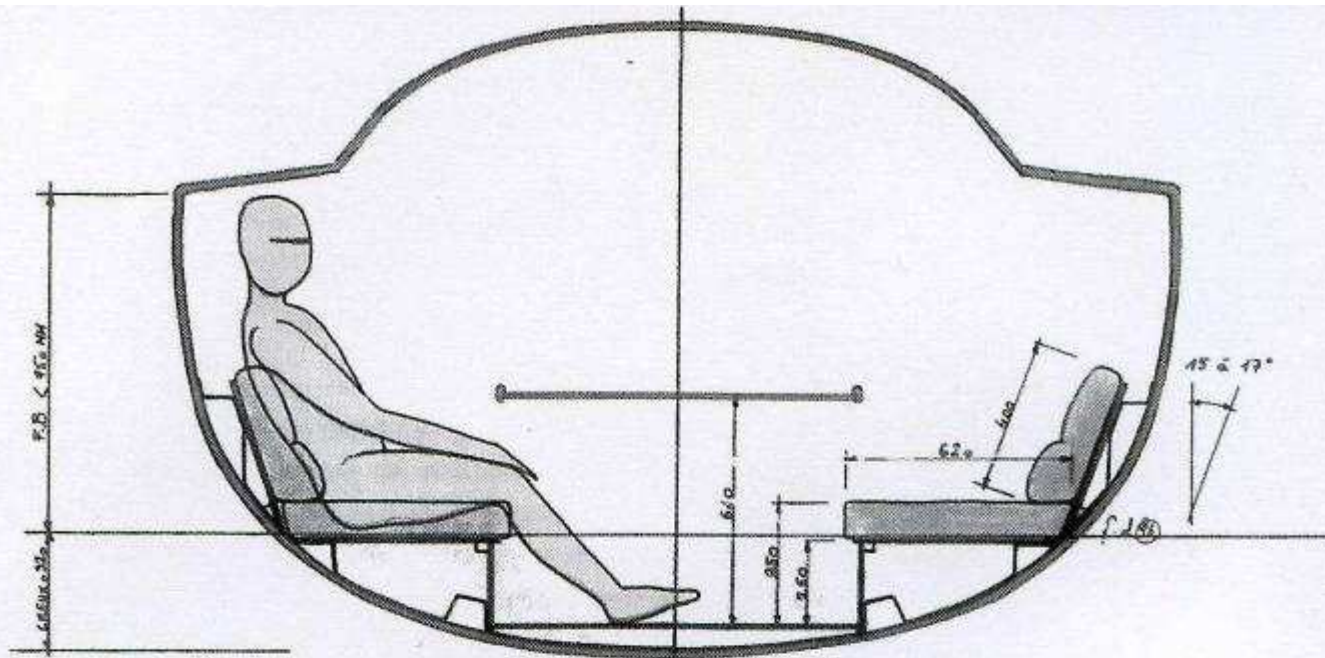

Fig. 7-8 • Couchettes superposées en position « nuit ». De jour, la couchette inférieure rentrée et le bord de la couchette supérieure rabattu transforment le tout en une banquette de carré de dimensions normales.



accroissement du franc-bord

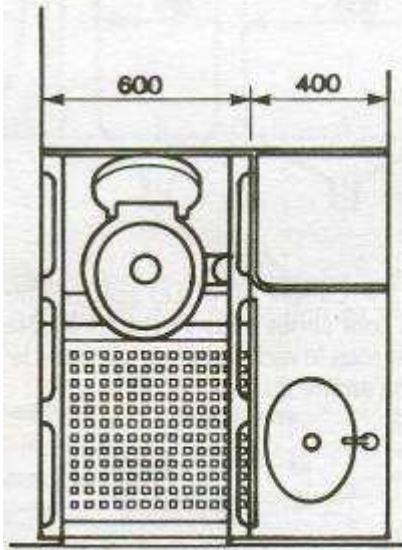
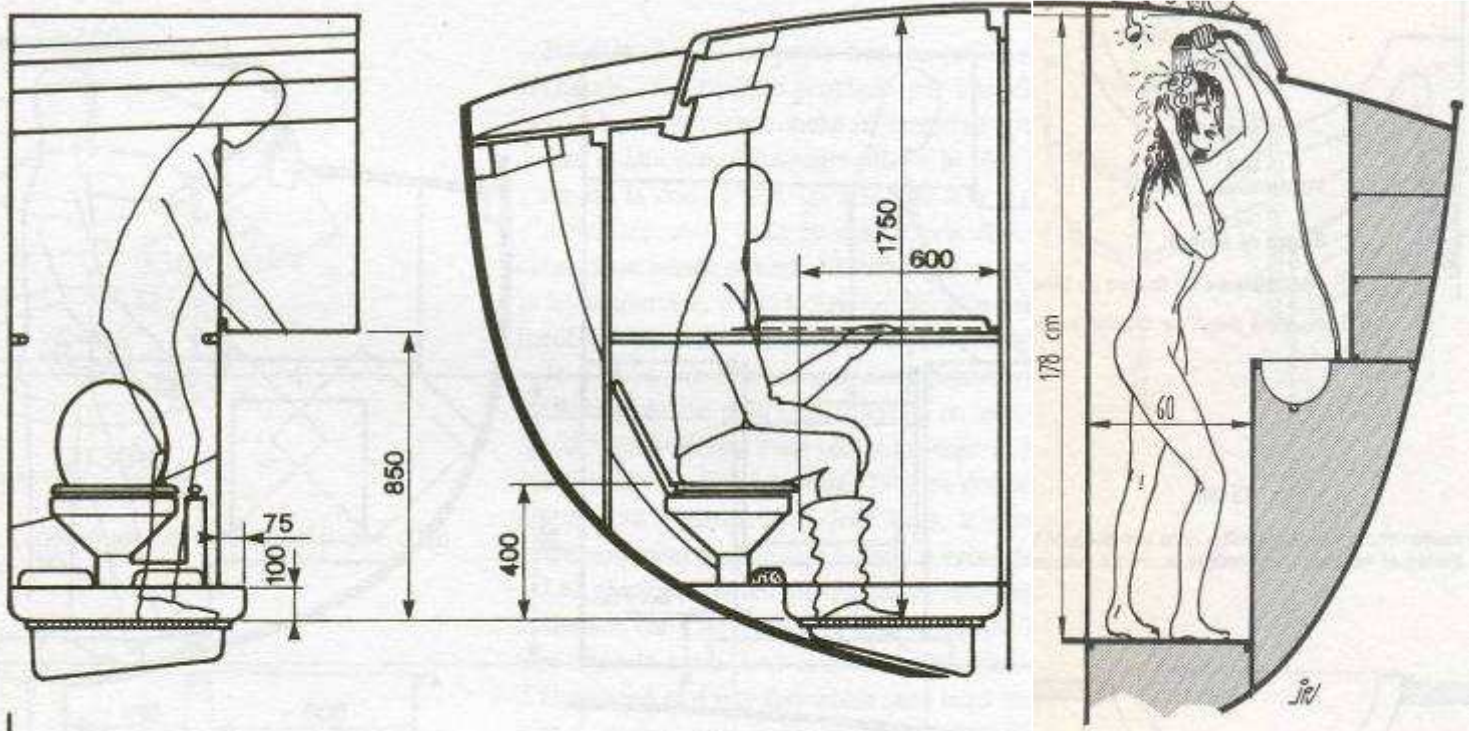
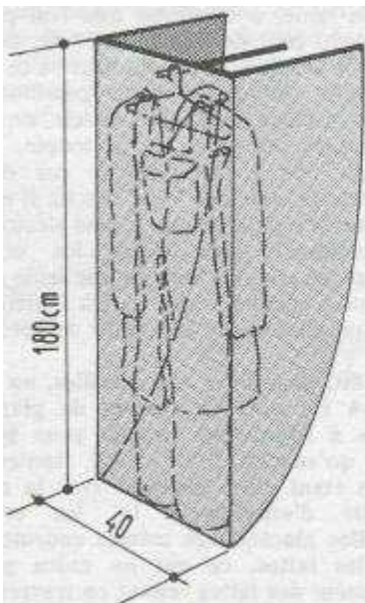
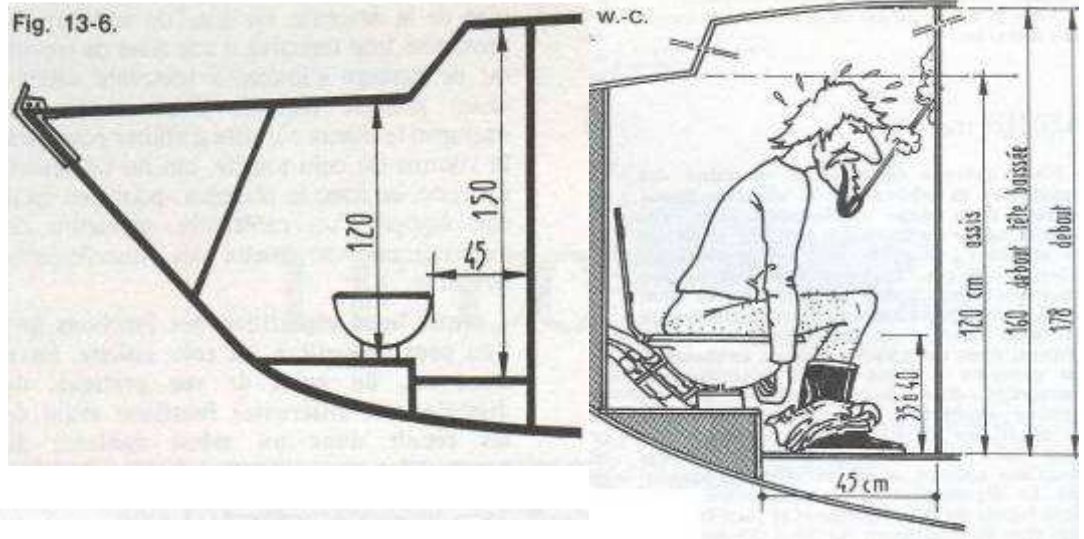
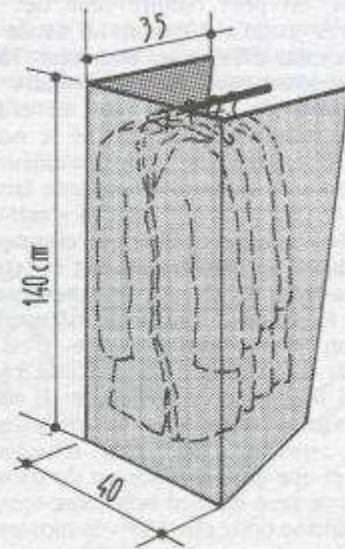

Fig. 13-6.



Ensemble ciré à pantalon-salopette à bretelles sur cintres



Cirés sur une série de cintres, les uns derrière les autres : solution prenant peu de place mais peu pratique.

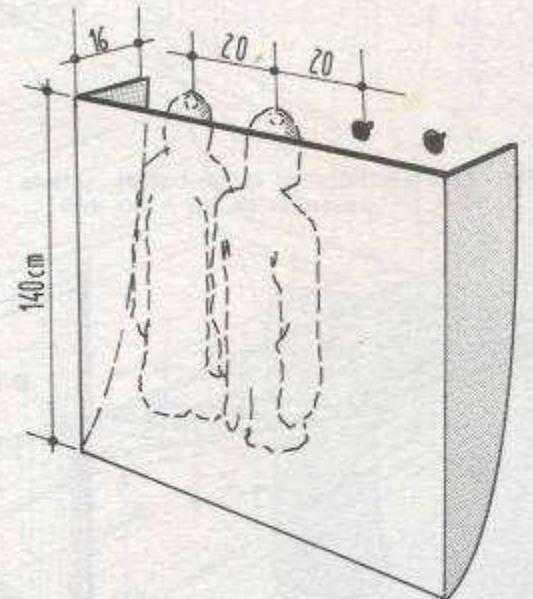

Cirés suspendus individuellement sur des portemanteaux muraux : pratique, chacun à sa place.

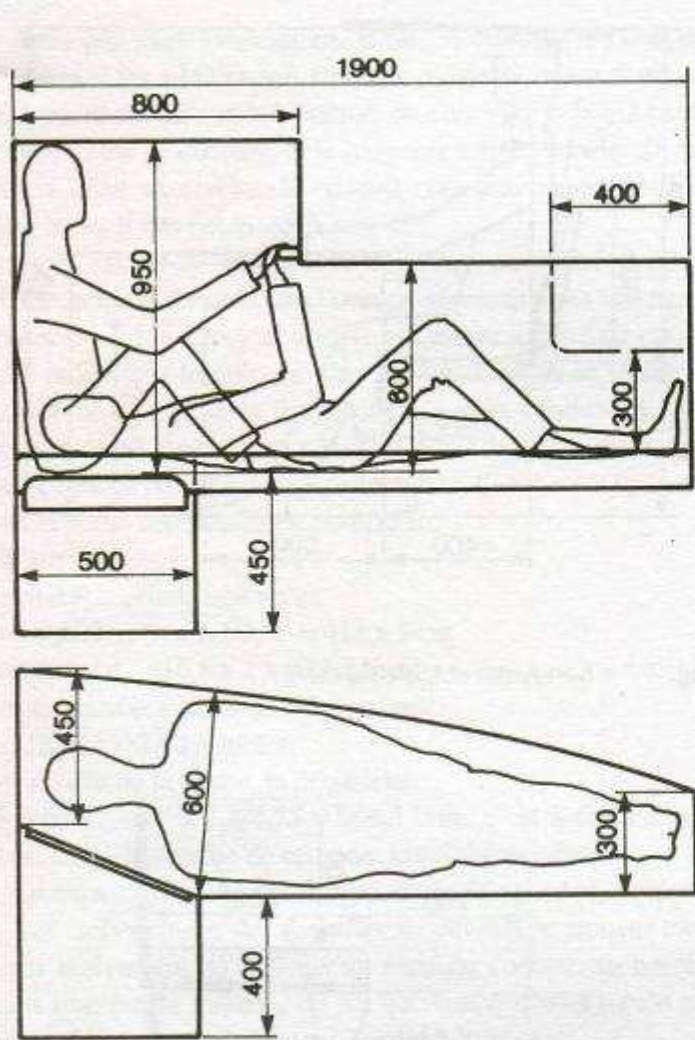

Fig. 7-9 • Dimensions d'une couchette de quart.

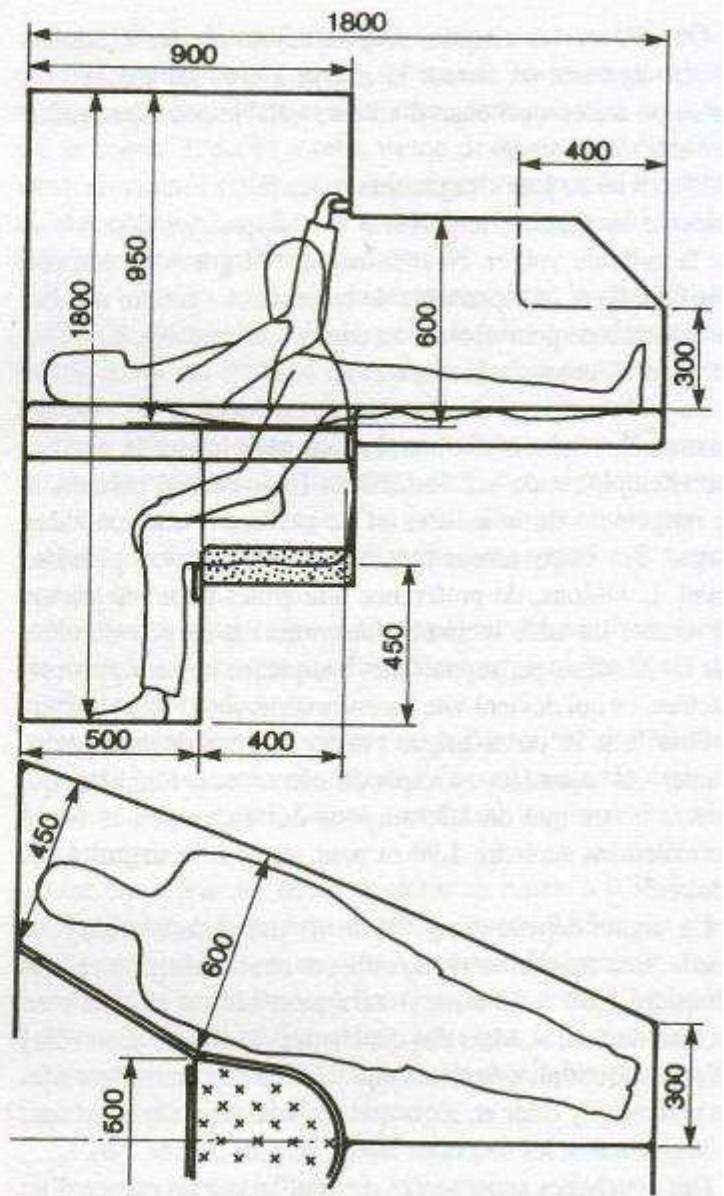

Fig. 4-4. - Se relever complètement.



Fig. 4-5. - Plier les genoux et se soulever à demi pour quitter une couchette simple...

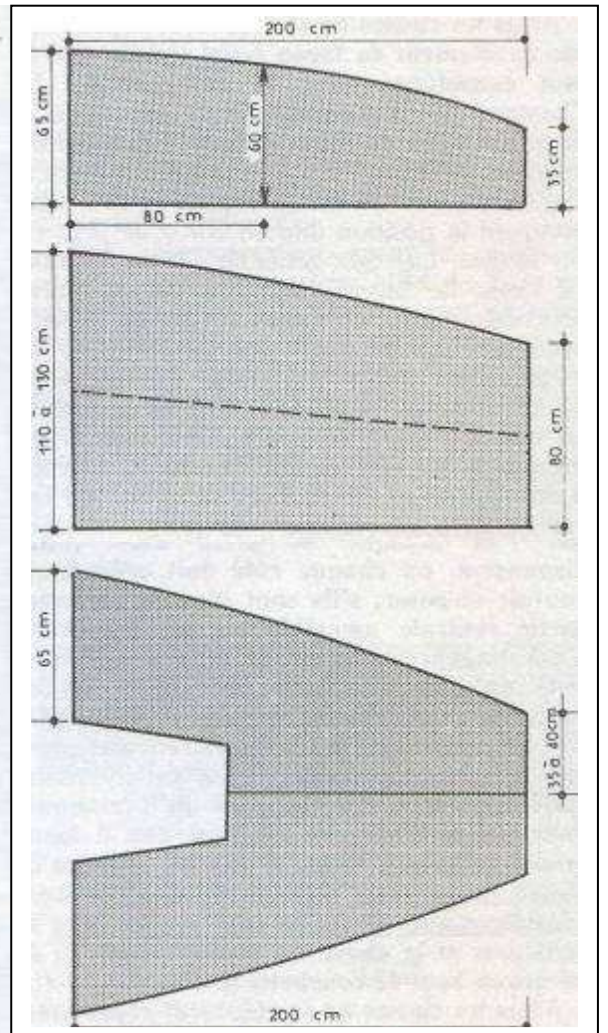
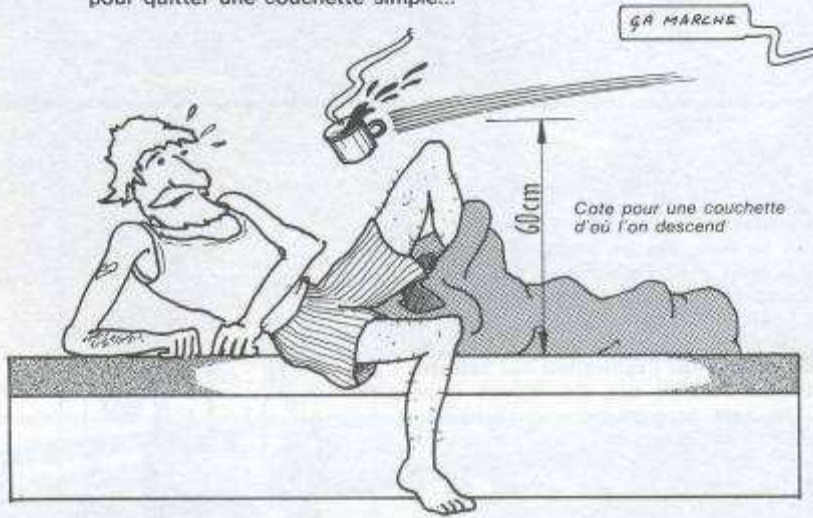

Fig. 4-6.

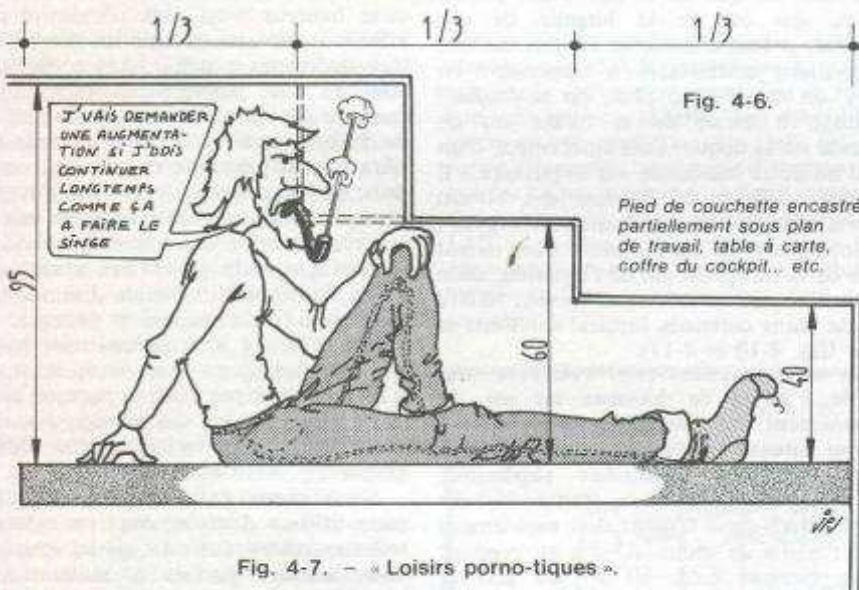
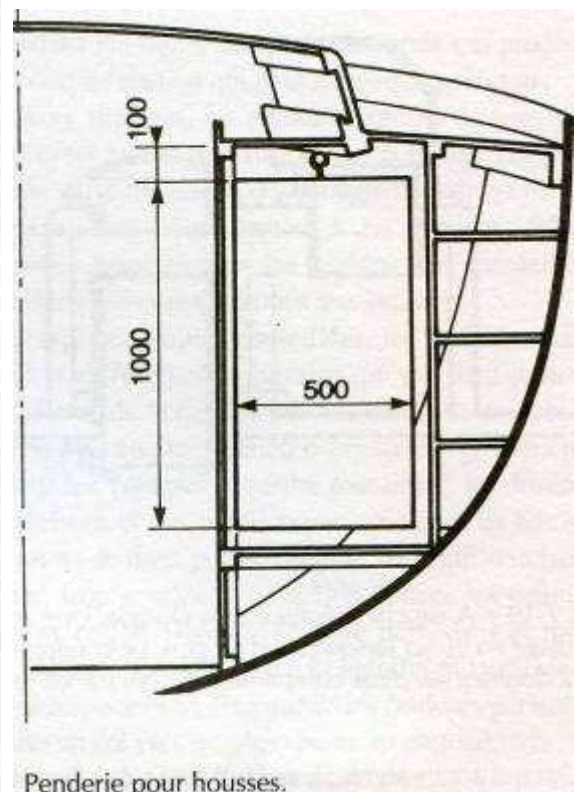

Fig. 4-7. - « Loisirs porno-tiques ».



Penderie pour housses.

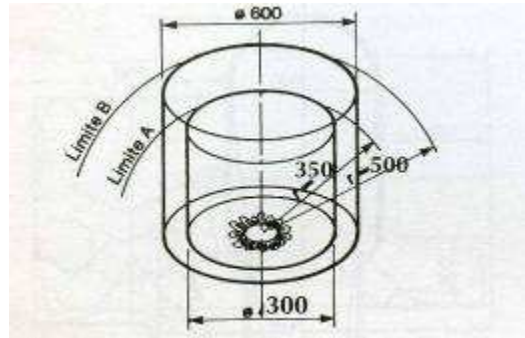
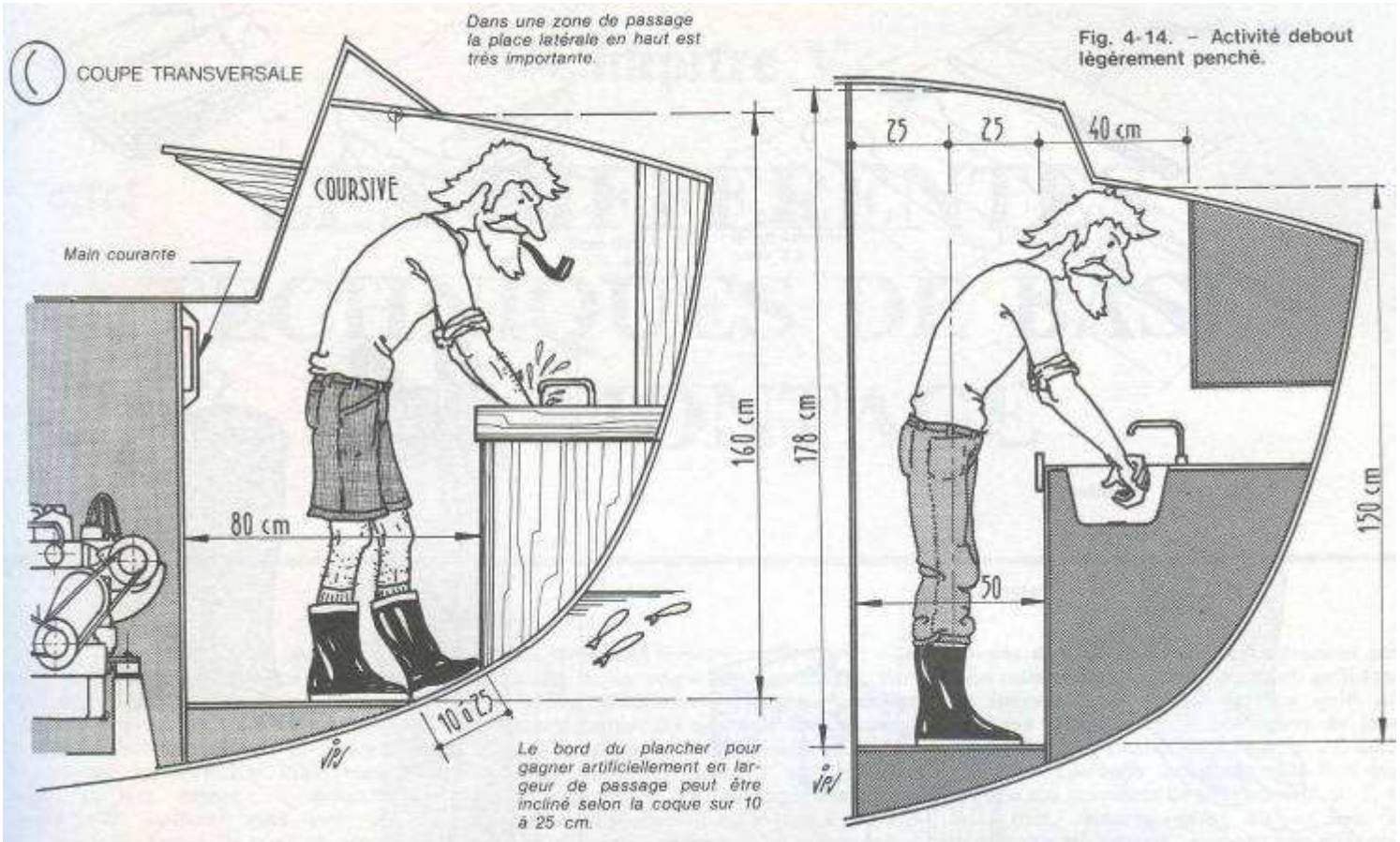

Fig. 7-12 • Limite de protection autour de la flamme d'un réchaud fonctionnant au GPL.

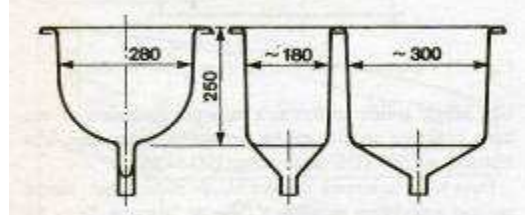

Fig. 7-13 • Vue en coupe transversale et longitudinale d'un évier double réellement adapté à la navigation en mer à la voile.

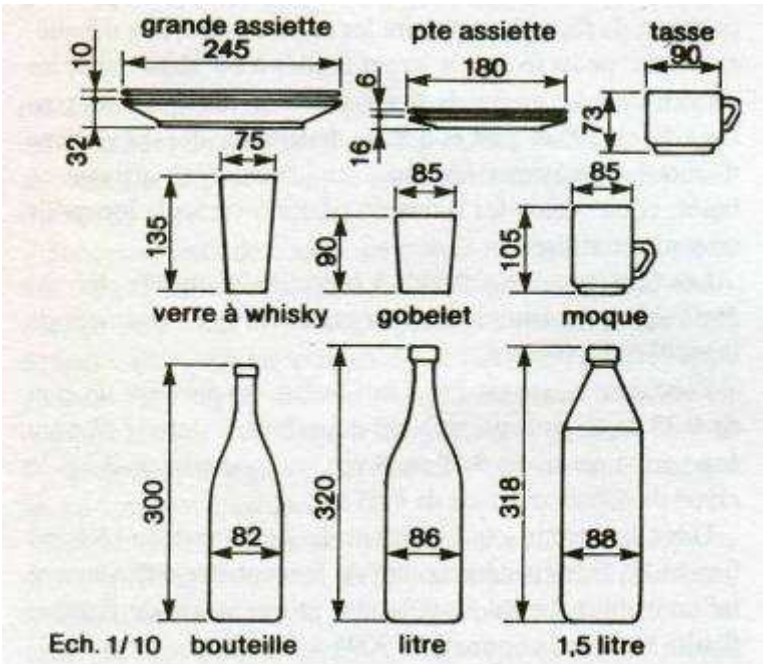

Fig. 7-14 • Dimensions de quelques objets de vaisselle et bouteilles.

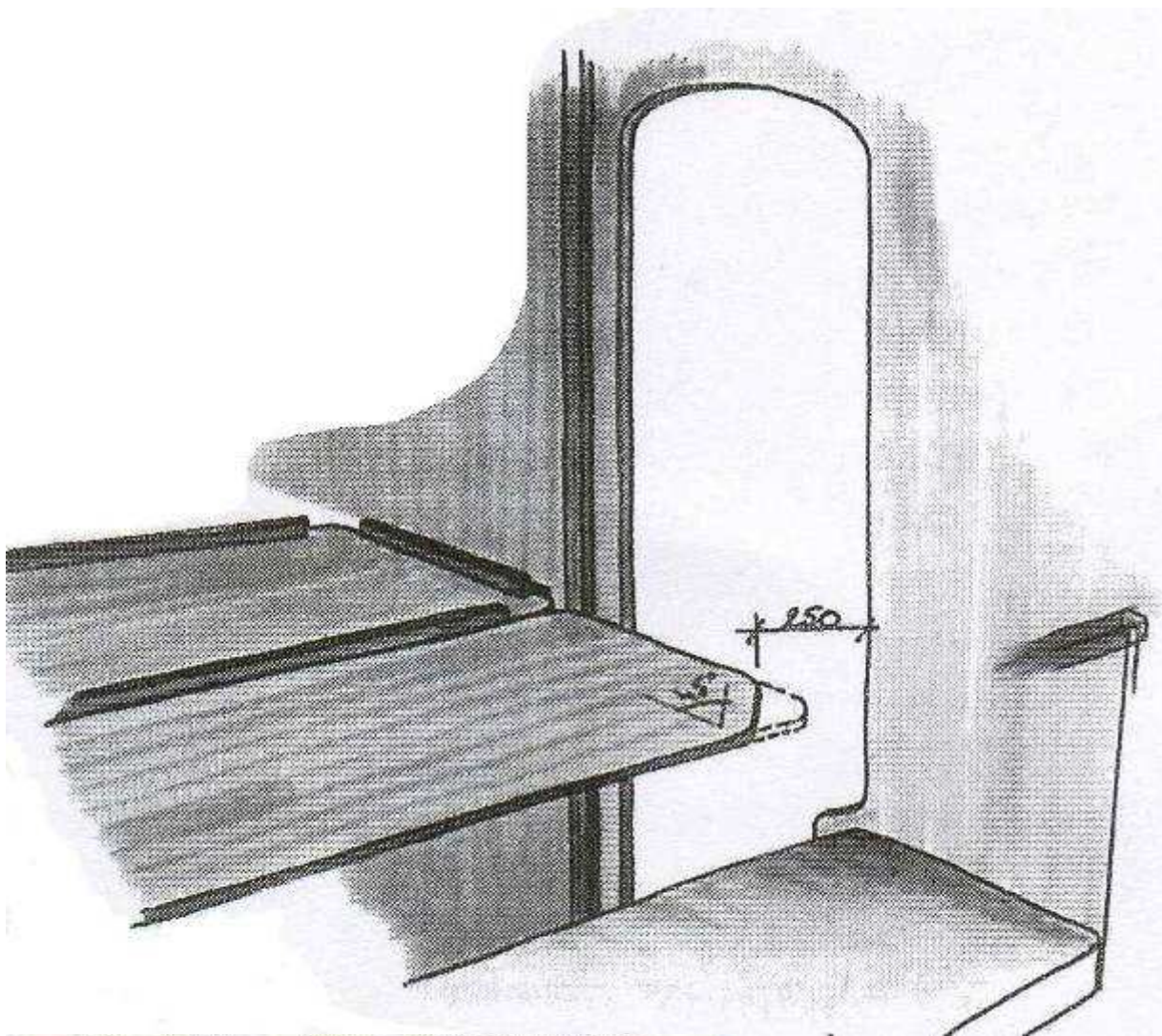

Fig. 4-12. - Côtes d'une ouverture (passage porte) oblique.

