

PS4000 C

Solar-operated Submersible Pump System

Characteristics

- flow rate up to 70 m³/h
- lift up to 170 m
- maintenance-free
- excellent efficiency thanks to modern brushless DC motor technology

Application

- drinking water supply
- livestock watering
- pond management
- irrigation
- etc.

Components

Controller PS4000

- controlling of the pump system and monitoring of the operating states
- mounted at surface (no electronic parts submerged)
- two control inputs for well probe (dry running protection), float or pressure switches, remote control etc.
- automatic reset 20 minutes after well probe turns pump off
- protected against reverse polarity, overload and high temperature
- speed control, max. pump speed adjustable to reduce flow rate to c. 30 %
- solar operation: integrated MPPT (Maximum Power Point Tracking), Voc = 375V DC, Vmp > 230V DC
- battery operation: low voltage disconnect and restart after battery has recovered
- max. efficiency 92% (motor + controller)
- enclosure: IP 54 (sealed, weatherproof)
- ambient temperature: -30 to +40° C / -20 to +115° F

Motor ECDRIVE 4000C

- 2-pole, synchronous brushless DC motor
- high life expectancy, electronically commutated, sensorless
- voltage: max. 240V EC (electronically commutated)
- power: 3.5 kW/4.6 HP, n_{max} = 3,300 RPM
- no electronics inside motor
- water filled
- IP68, pressure balanced, unlimited submersion
- water lubricated dynamic slide bearings, material: carbon/ceramic
- raw earth magnets, sealed in stainless steel and encapsulated in synthetic resin
- unlimited number of starts/stops per hour
- wetted material: stainless steel (AISI 316), POM, rubber, cable drinking water approved
- max. water temperature: 40° C/105° F

Pump End (PE)

- centrifugal multistage direct-coupled pump end
- non-return valve
- material: stainless steel (AISI 304), rubber
- dry running protection (optional)
- max. sand content: 50 g/m³, a higher content will wear the pump and reduce its life span considerably
- max. salt content: 300–500 ppm at max. 30° C/85° F, higher salt contents require lower water temperatures
- pH value: 6-9
- high life expectancy

Motor and controller can only operate as unit. The motor cannot be operated without controller or with a different controller.



PS4000 C

Solar-operated Submersible Pump System



Performance

Pump Head	Lift		Flow Rate	
	[m]	[ft]	[m³/h]	[US-Gal./h]
C-SJ3-32	130–170	430–560	3.3–3.8	800–1,000
C-SJ5-25	70–130	260–430	4.3–6.6	1,150–1,720
C-SJ8-15	30–80	100–260	6.9–12.2	1,700–3,200
C-SJ17-4	15–50	50–165	14.0–24.5	3,700–6,500
C-SJ30-2	12–22	40–70	33–44	8,500–11,000
C-SJ42-1	up to 12	up to 40	44–70	11,000–18,500

Daily Flow Rate | 8.5 peak flow hours per day, PV generator* 5 kWp, Vmp > 230VDC, tracked, 6 kWh/m²/day

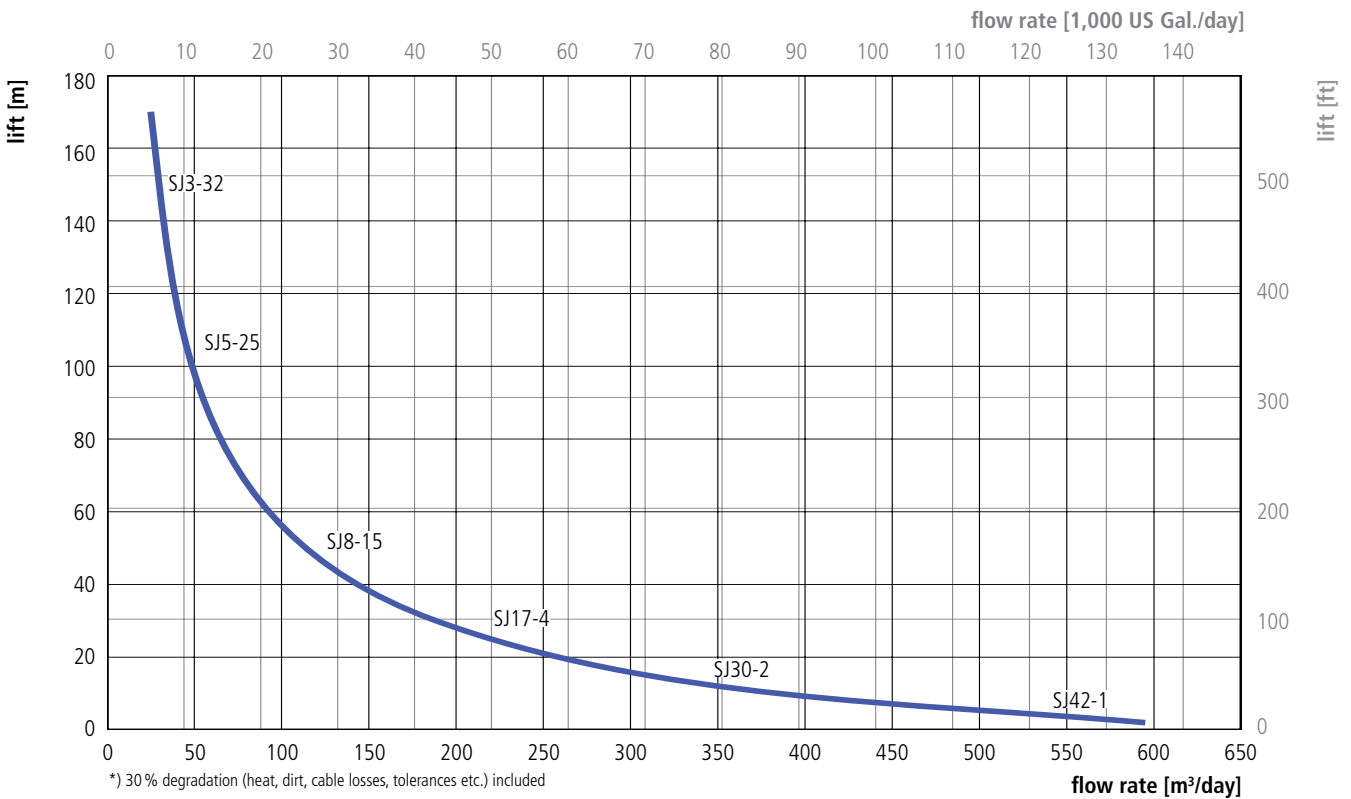

Dimensions

Pump	Dimensions						Minimum internal borehole diameter	Weight [kg]
	A	B	C	D	E _{max}	BSP		
	[mm]	[mm]	[mm]	[mm]	[mm]	[in]	[in / mm]	
SJ3-32	1,088	245	843	96	98	1 ¼	4 / 104	19.5
SJ5-25	941	245	696	96	98	1 ½	4 / 104	18.0
SJ8-15	1,118	245	873	96	98	2	4 / 104	20.5
SJ17-4	754	245	509	96	131	2 ½	6 / 150	20.5
SJ30-2	705	245	460	96	131	3	6 / 150	19.5
SJ42-1	625	245	380	96	147	3	6 / 150	18.0

Controller					
PS4000	595	178	165	150	6.0

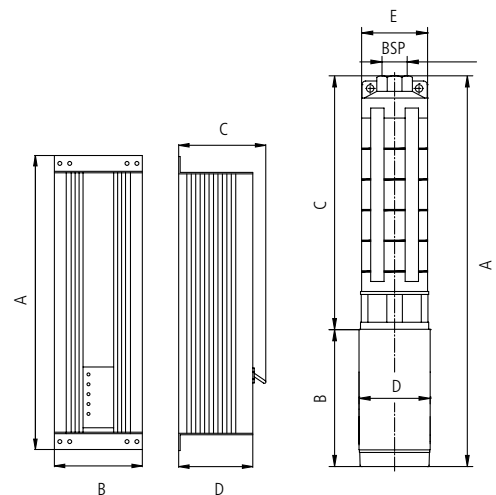

PS4000 C-SJ3-32 (Item No. 1280) for Solar Operation



System Performance

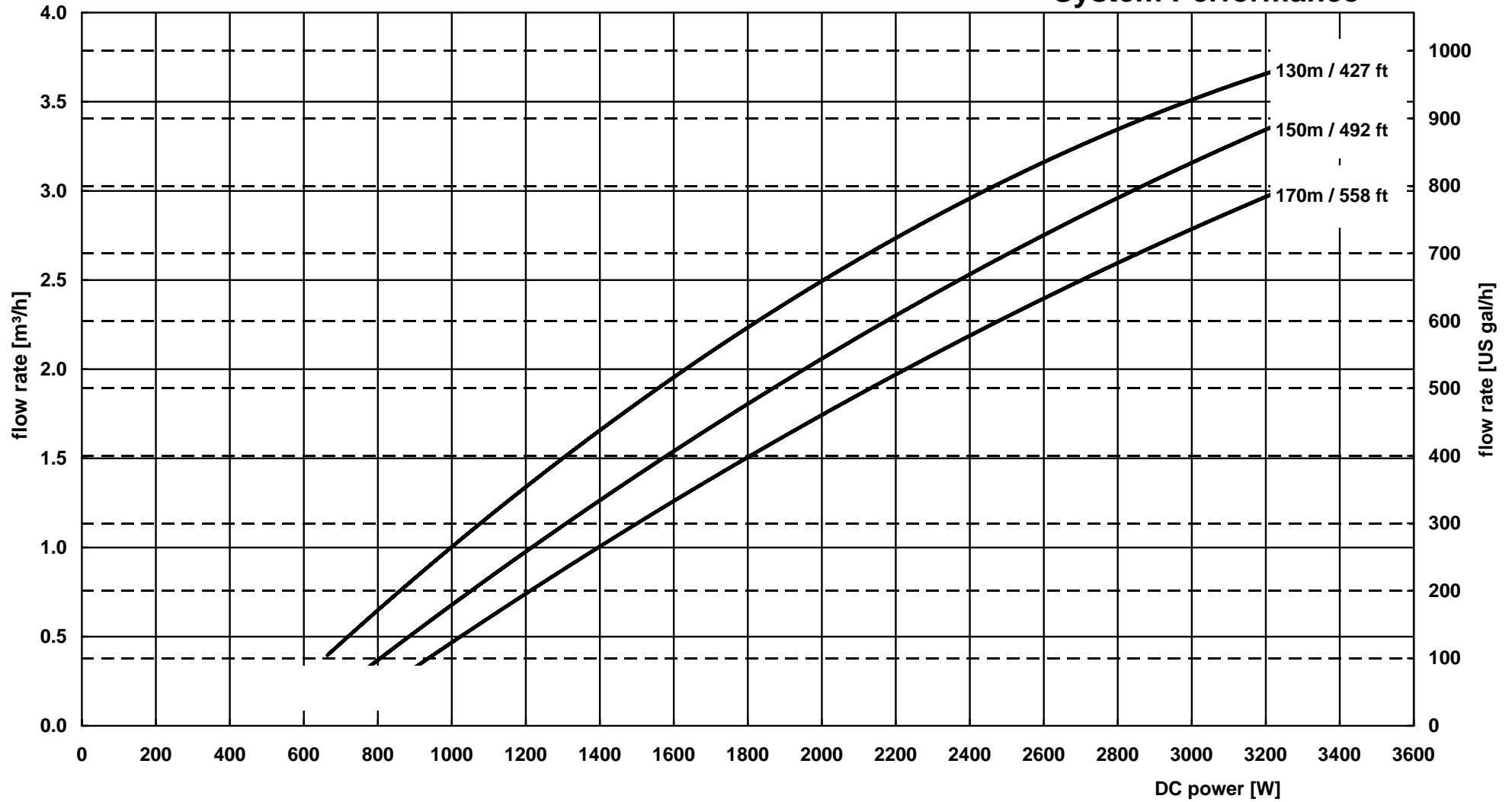

PS4000 C-SJ5-25 (Item No. 1281) for Solar Operation



System Performance

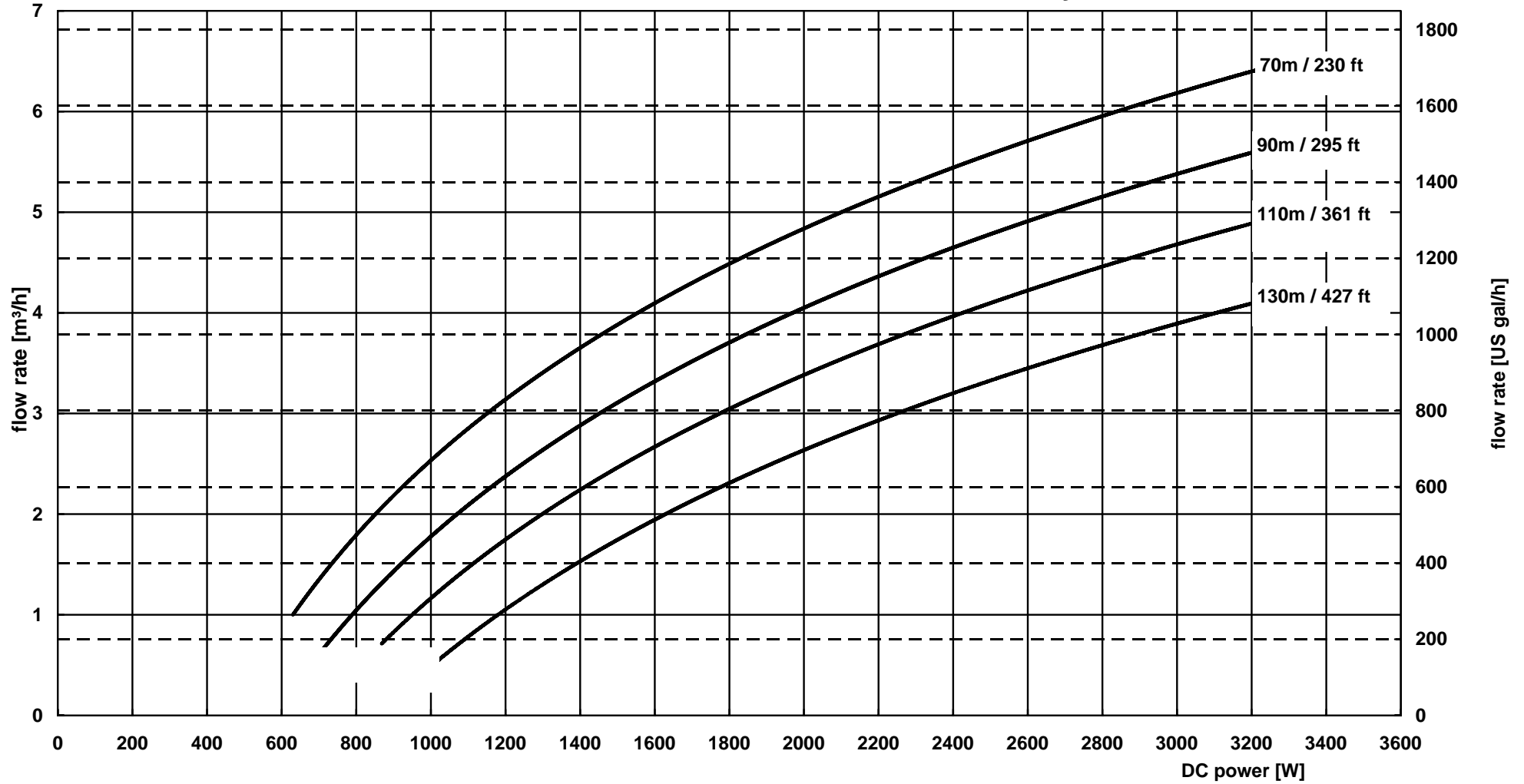

PS4000 C-SJ8-15 (Item No. 1282) for Solar Operation



System Performance

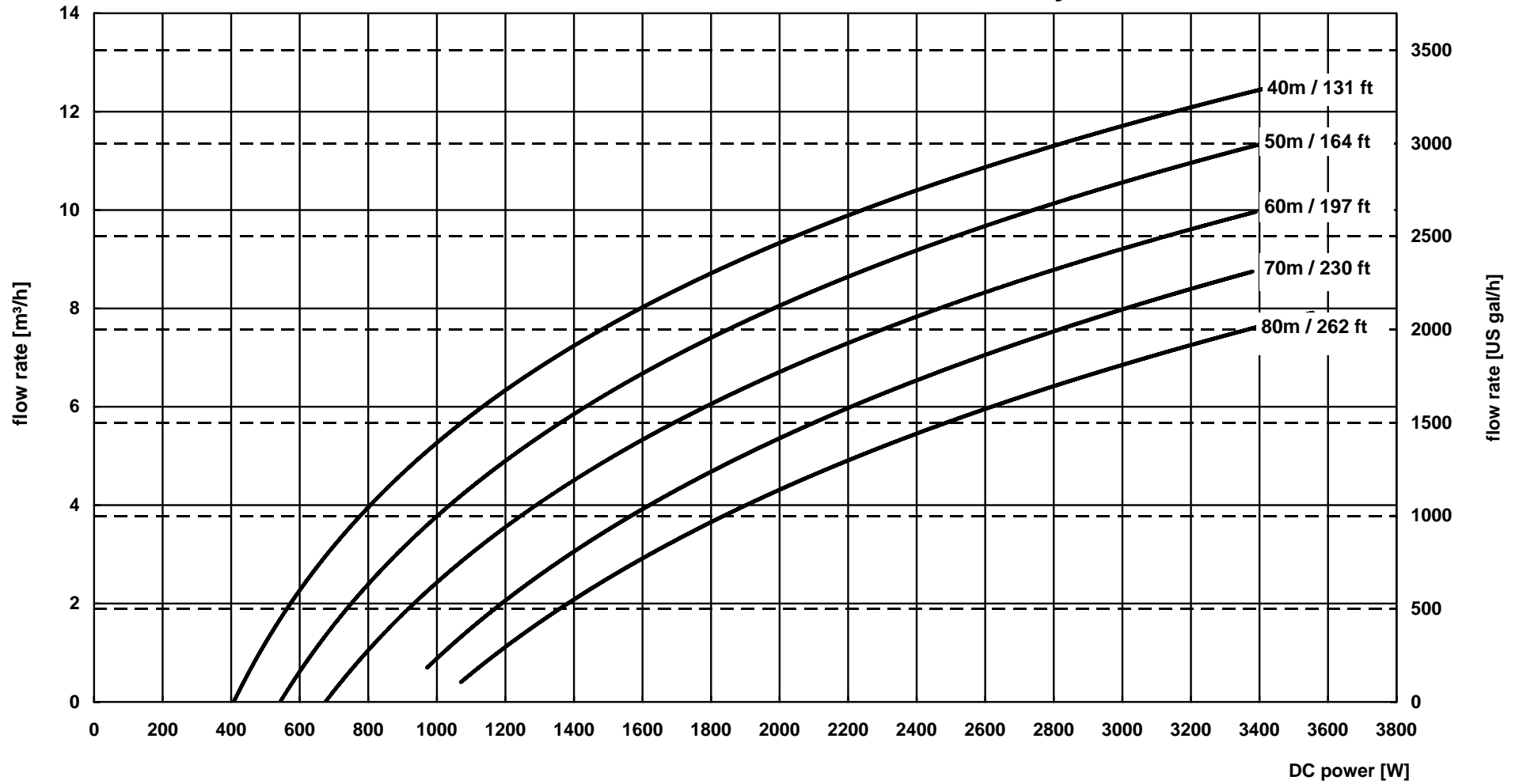

PS4000 C-SJ17-4 (Item No. 1286) for Solar Operation



System Performance

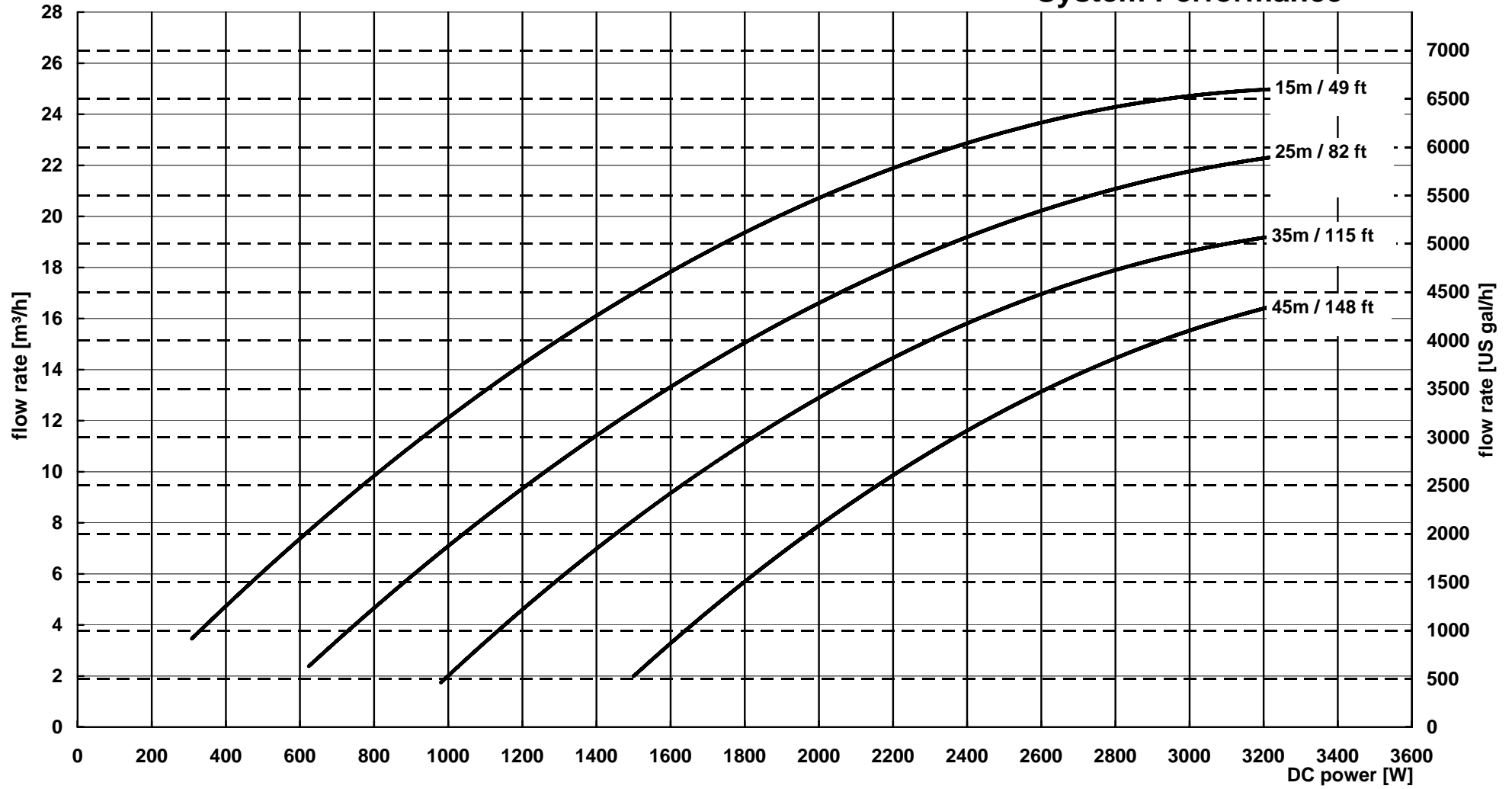

PS4000 C-SJ30-2 (Item No. 1288) for Solar Operation



System Performance

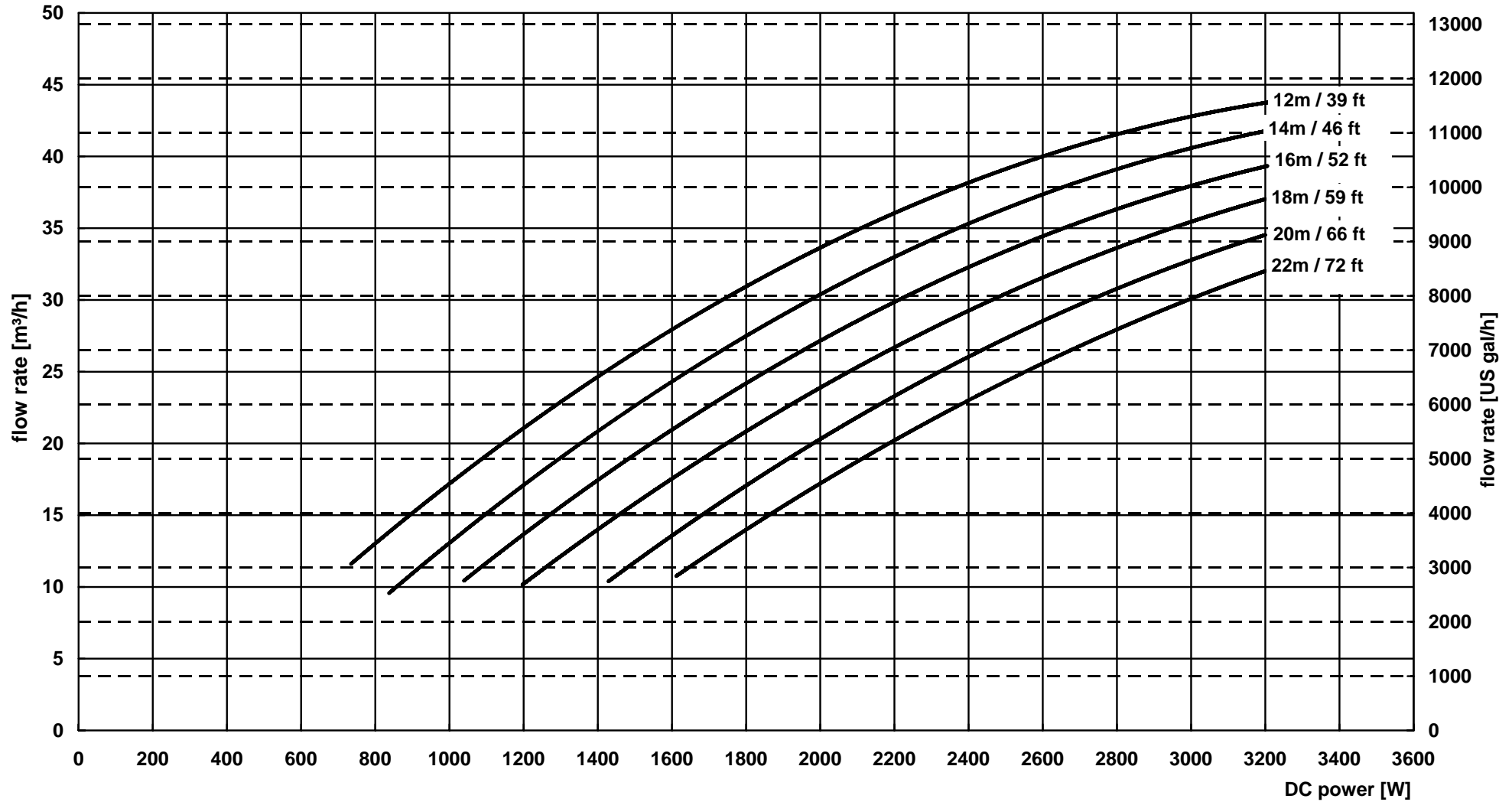

PS4000 C-SJ42-1 (Item No. 1289) for Solar Operation



System Performance

